

# SCF-150.9Z

Fixed Type Vacuum Capacitor (FS36 Type)

## Specification

Peak Test Voltage	15kV,peak (at 50,60 Hz/ 1 minute)
RF Working Voltage	9 kV,peak (at 13.56 MHz)
Capacitance	90 pF
Maximum Current	48 A,rms (at 13.56 MHz)
Total Length	43 mm
Outer Diameter	φ36 mm
Mounting Length	43 mm
Weight	0.13 kg



## Drawing

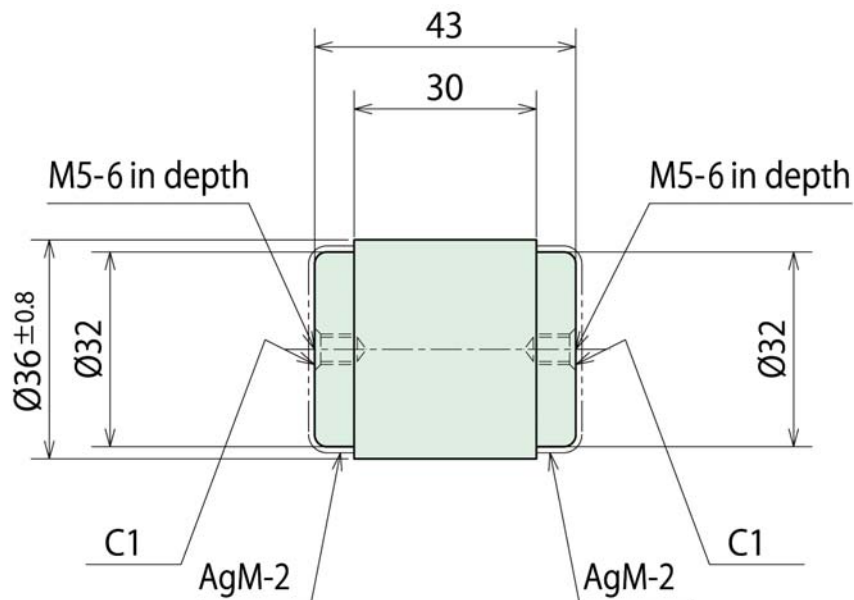

# SCF-150.9Z

Fixed Type Vacuum Capacitor (FS36 Type)

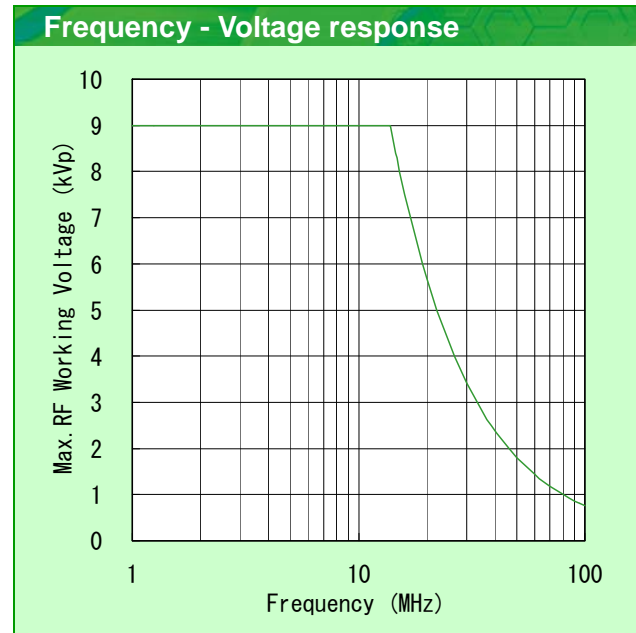
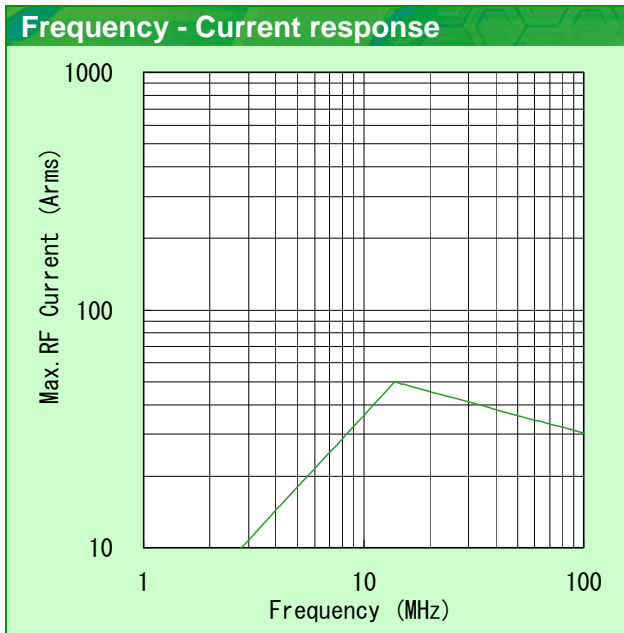

**Notice:**

- Current collecting system: Capacitor both-end full-face collection.
- Cooling System: Convection.
- Permissible surface temperature: 125°C.  
(The surface temperature changes with current collecting conditions and ambient temperature.)
- Ambient temperature: 25°C.